

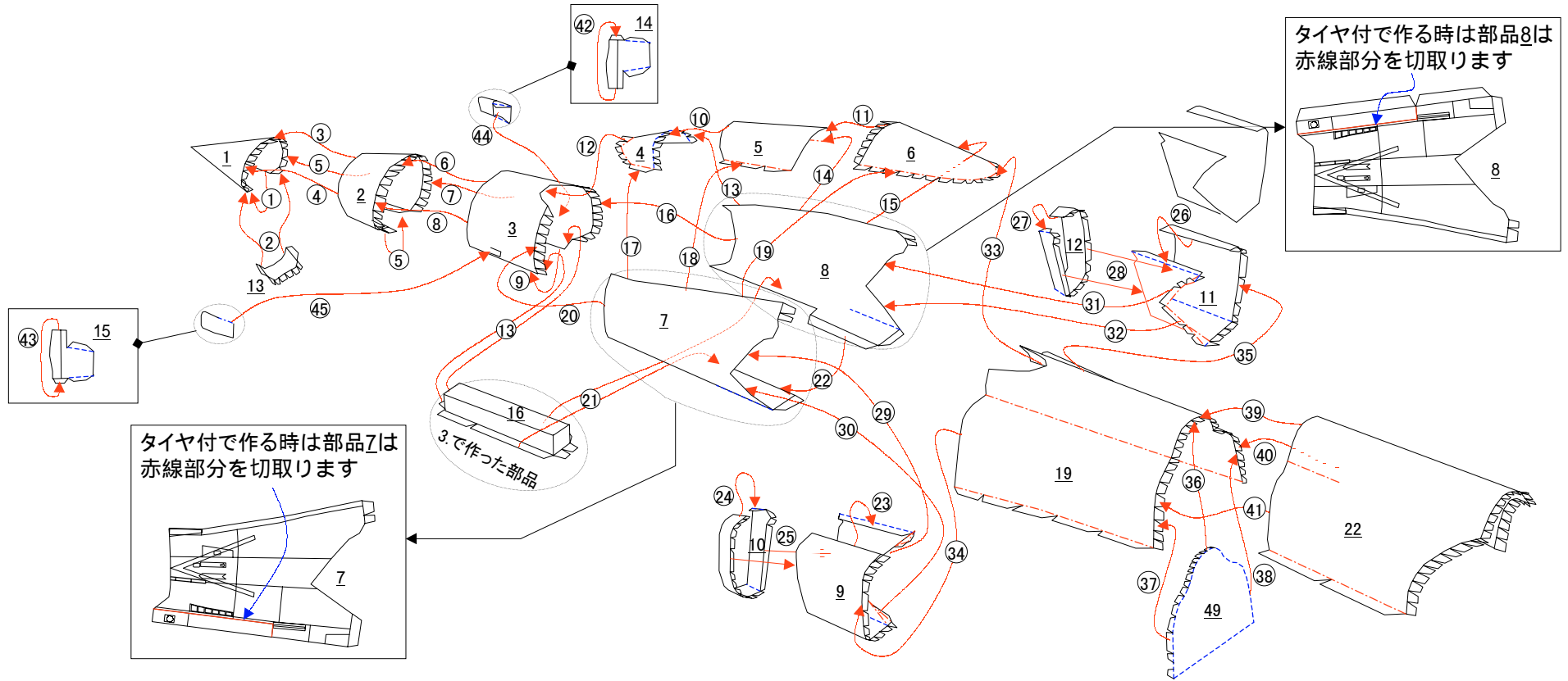

5.

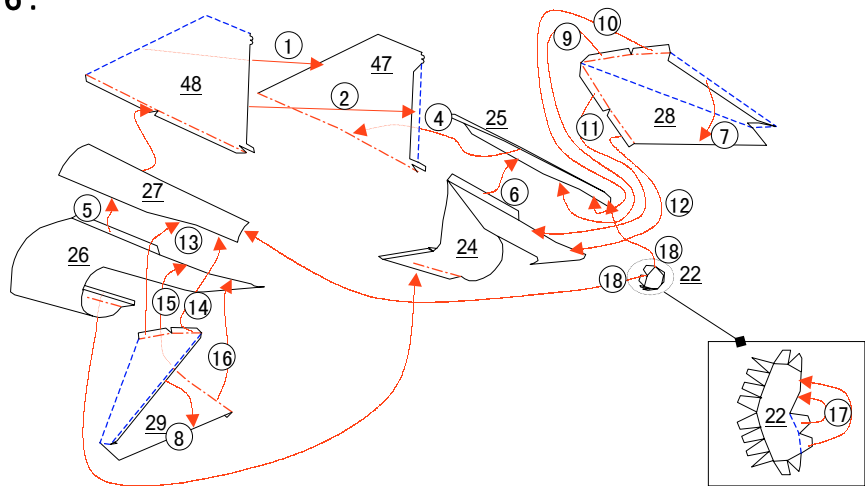

6.



7.

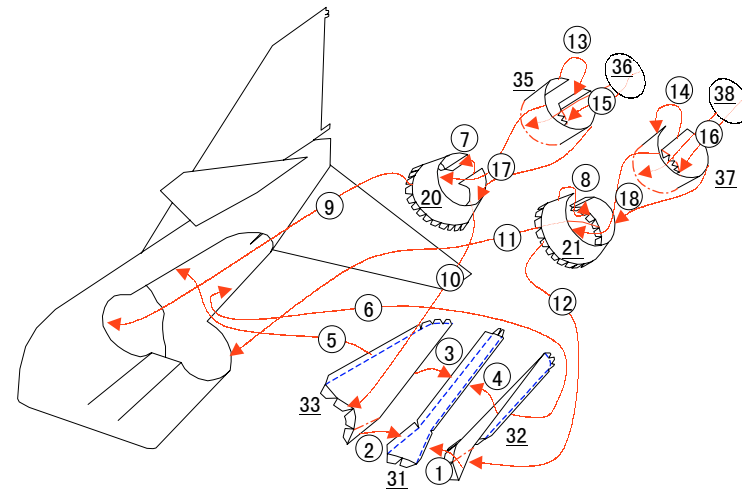

8. タイヤ無しで作るときは61・71の部品は不要です。

タイヤ付で作る時は部品39は赤線部分を切取ります

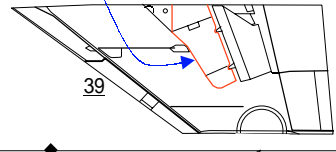

4で作った部品

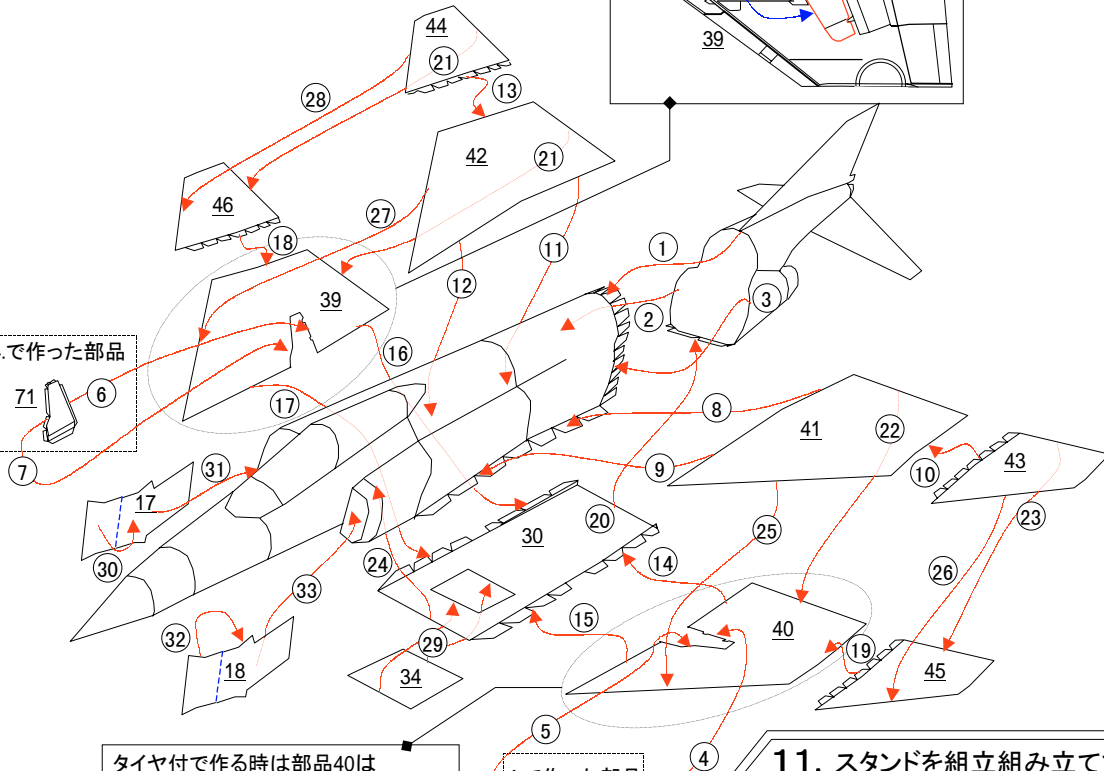
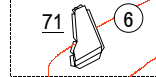

タイヤ付で作る時は部品40は赤線部分を切取ります

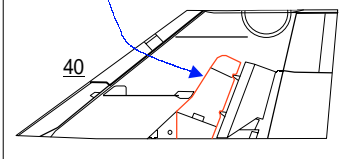

4で作った部品

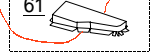

9. 81~85を組み立てた後86~90・91~95も同様に組み立てます。

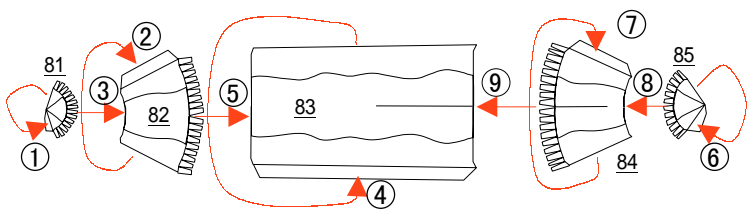

10. タイヤ無しで作るときは⑥までで⑥~⑨の作成は不要です。

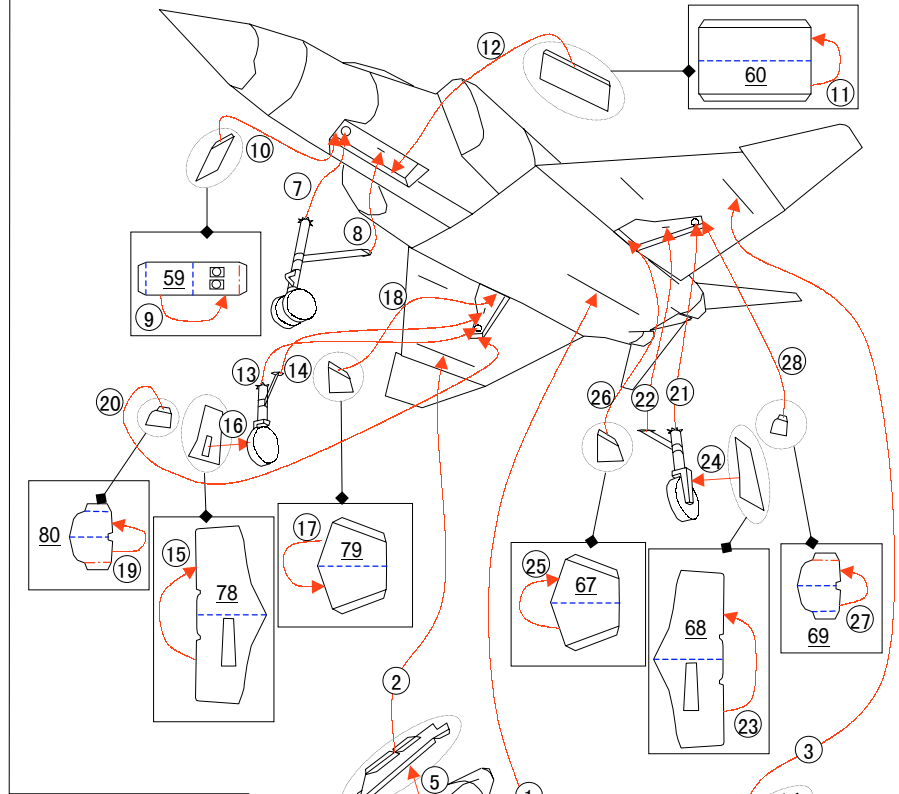

11. スタンドを組み立組み立てて完成です。

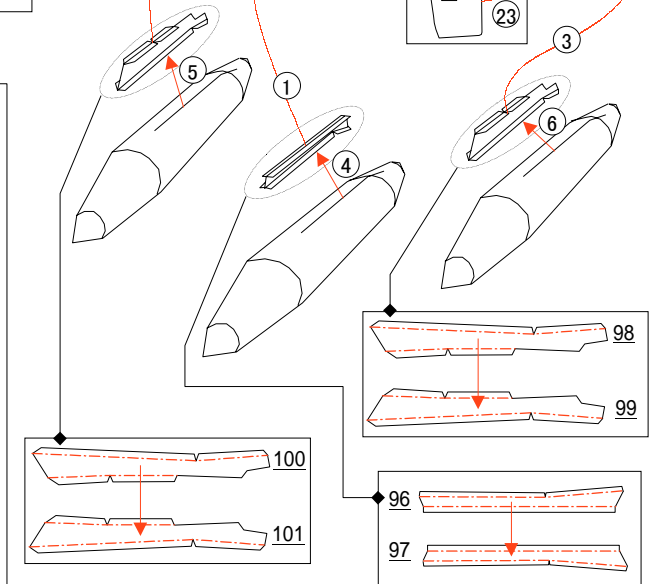
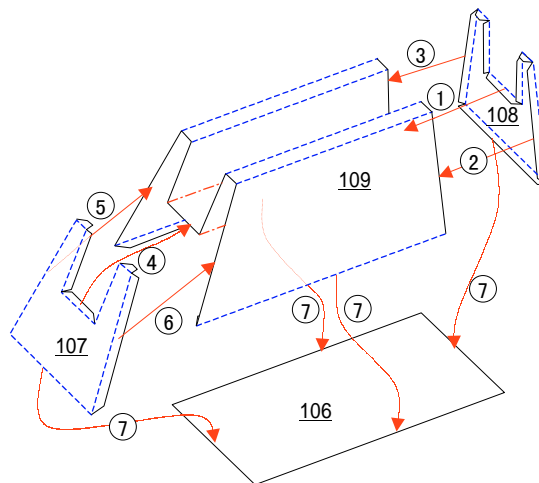

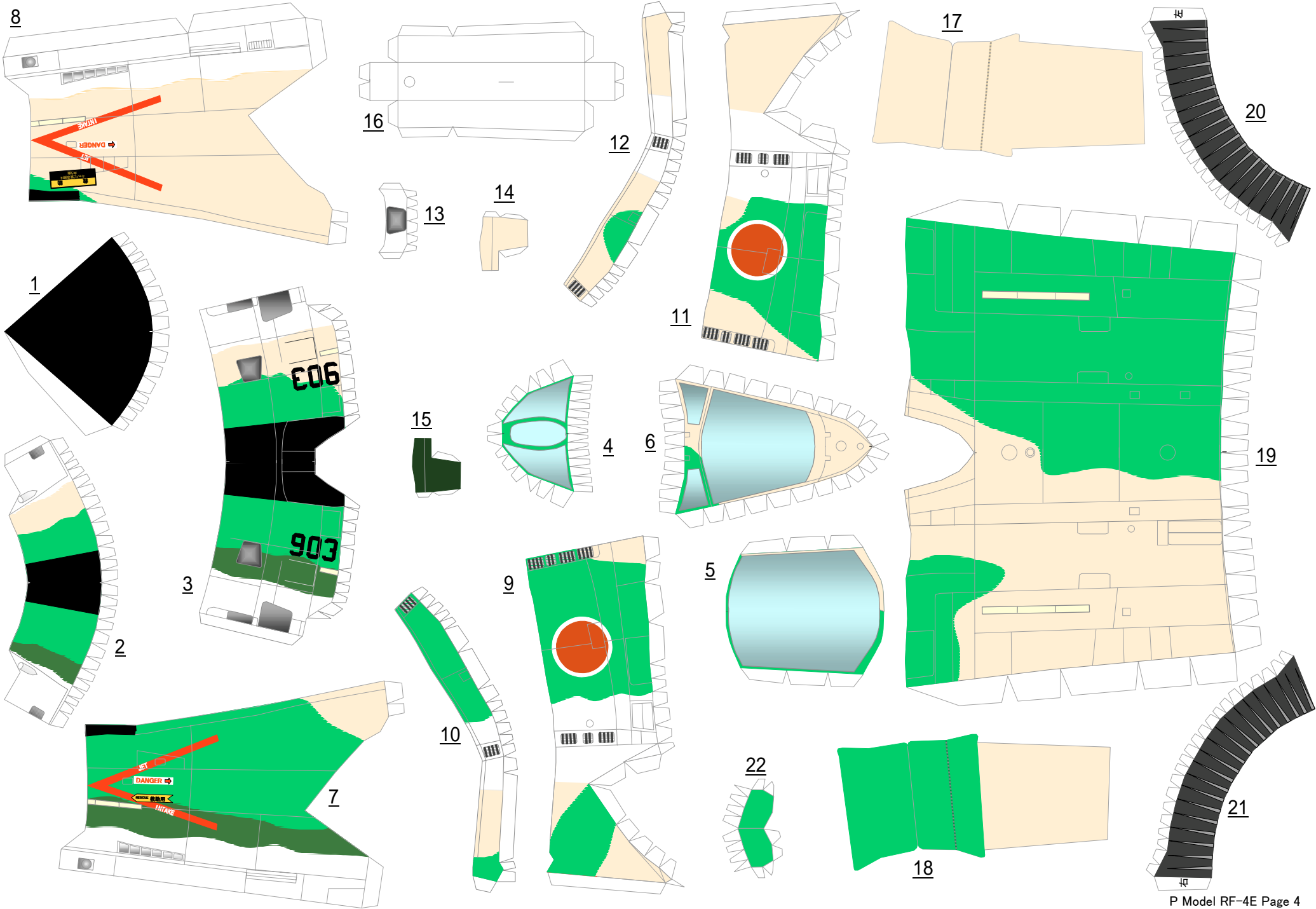

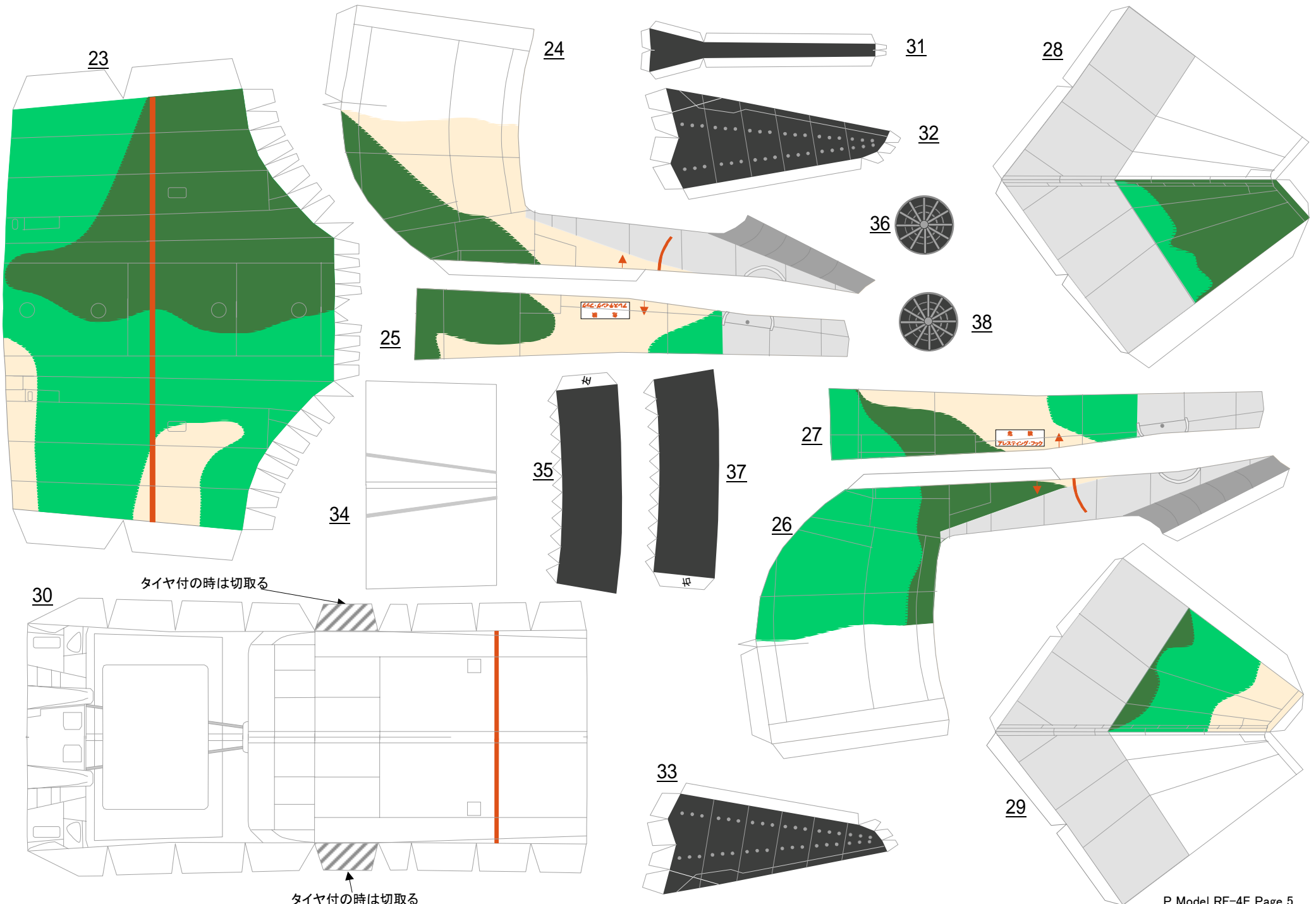

タイヤ付の時は切取る

タイヤ付の時は切取る

