

3.

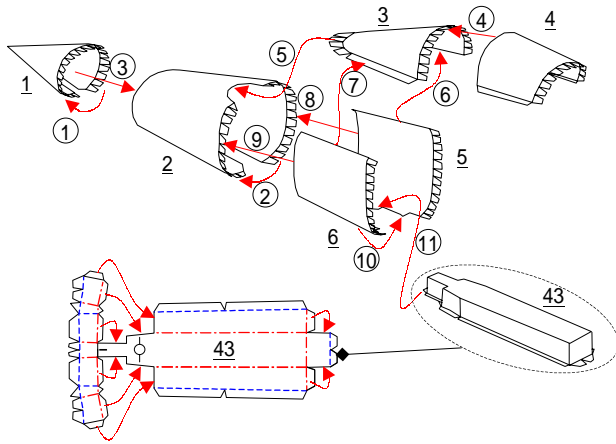

4. この時点で機首側にオモリ(板鉛等)を入れておいてください。

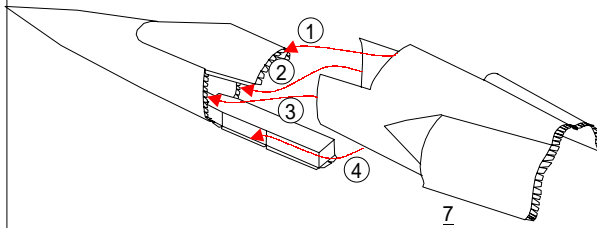

5.

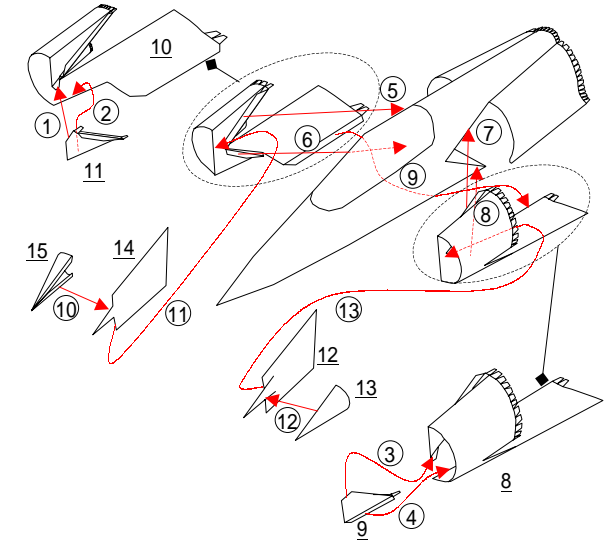

6.

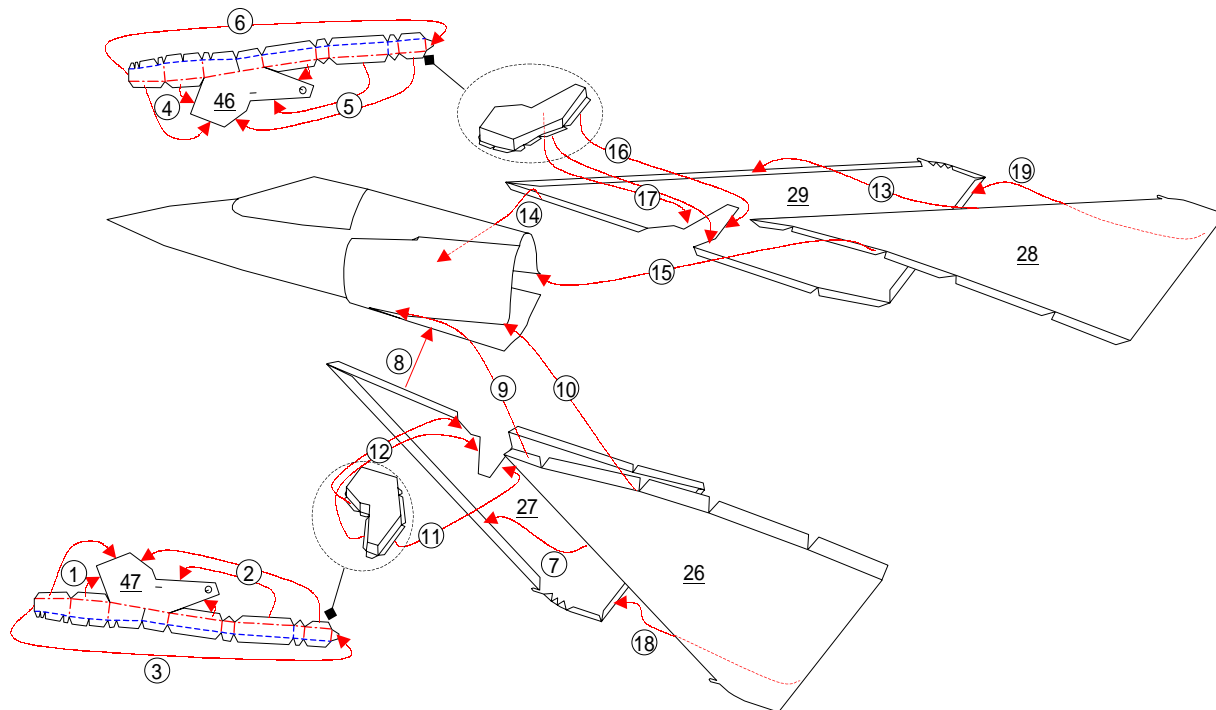

7.

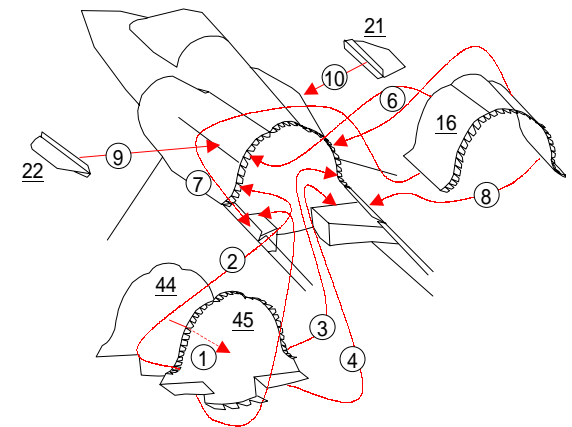

8.

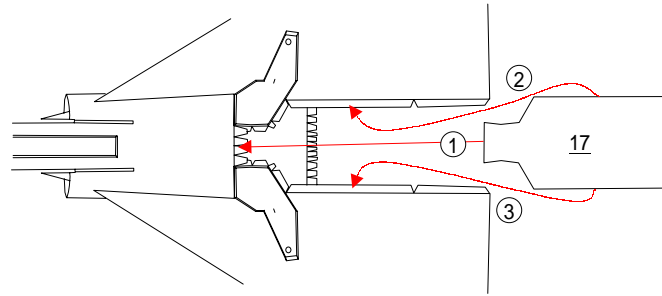

9.

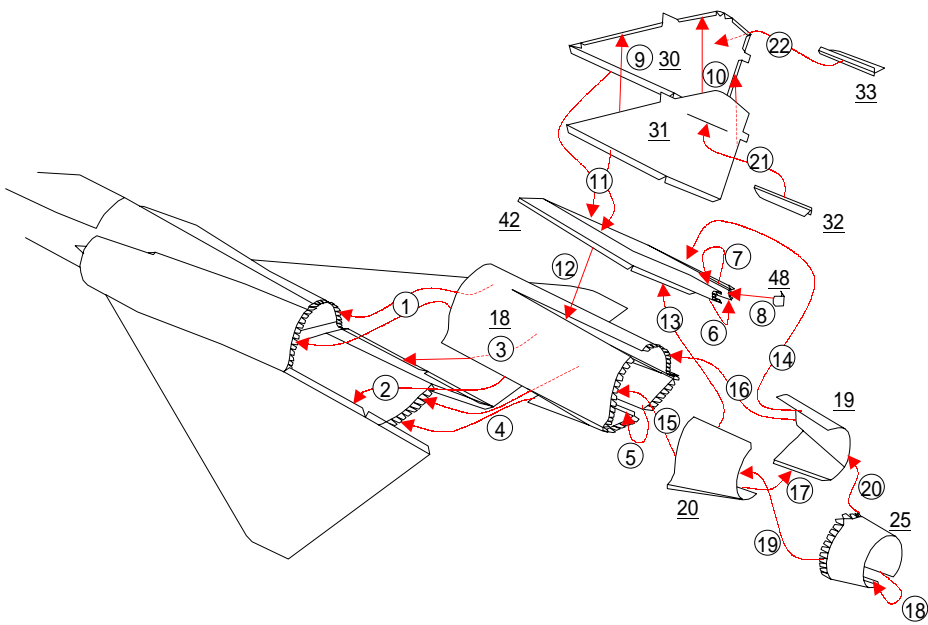

10. 車輪を付けるときはA枠内、車輪を付けないときはB枠内を作ります。

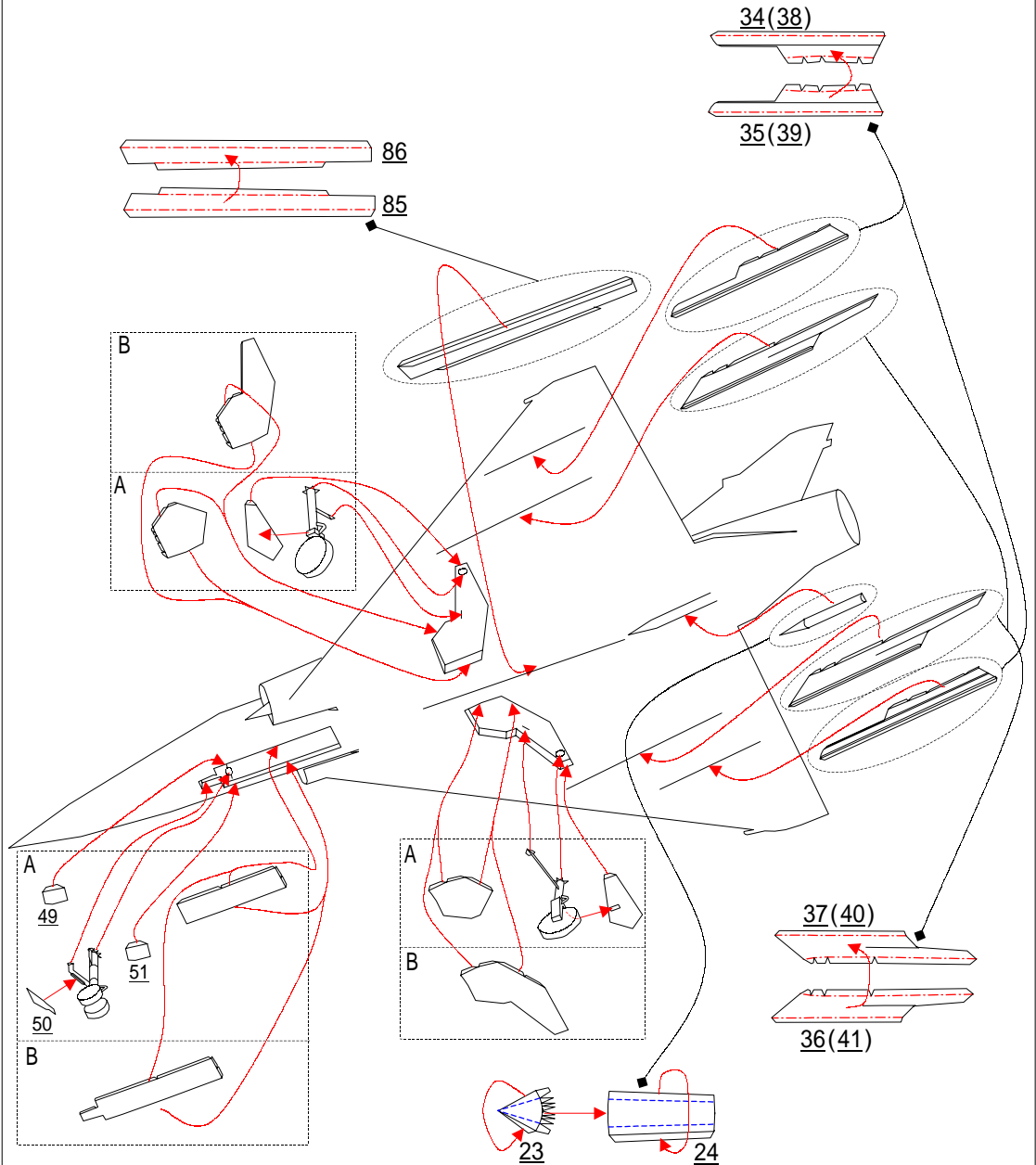

マトラ550マジックミサイル 組み立て説明

シュペル530ミサイル 組み立て説明

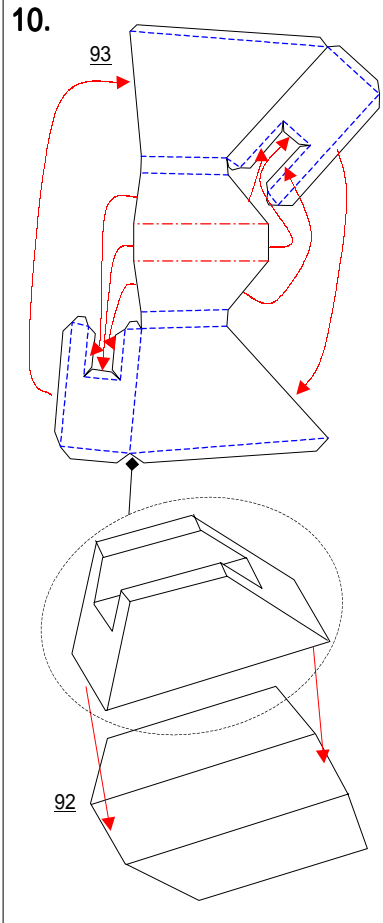

1. 点線部分で切り取ってのり代がわの角から丸めて、丸め終わったら の部分を切り離してから接着します。

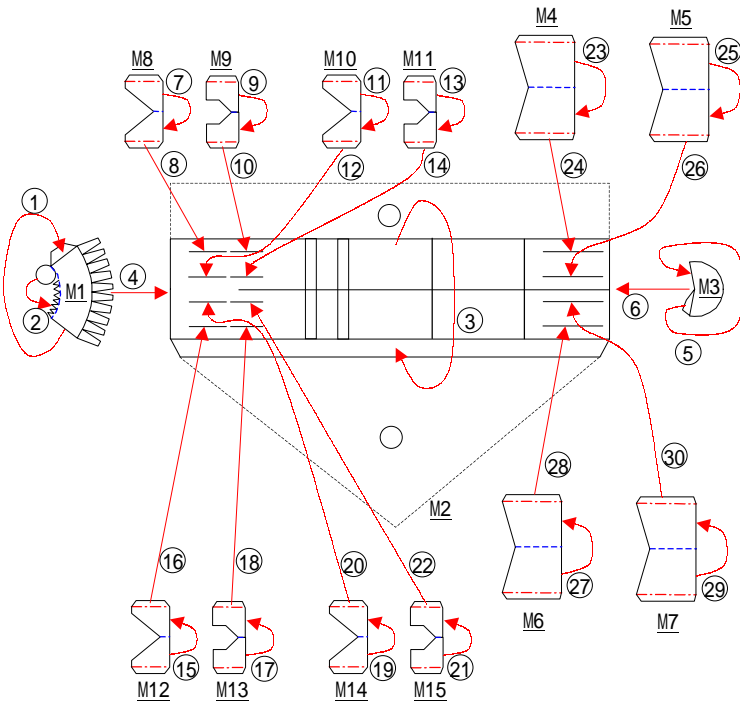

1. 点線部分で切り取ってのり代がわの角から丸めて、丸め終わったら の部分を切り離してから接着します。

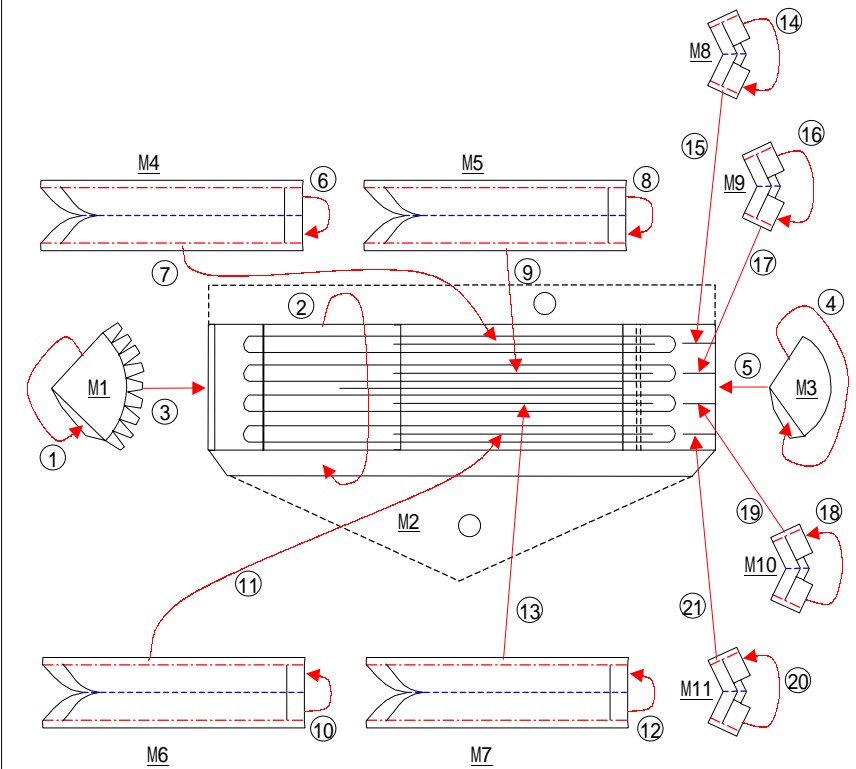

11.

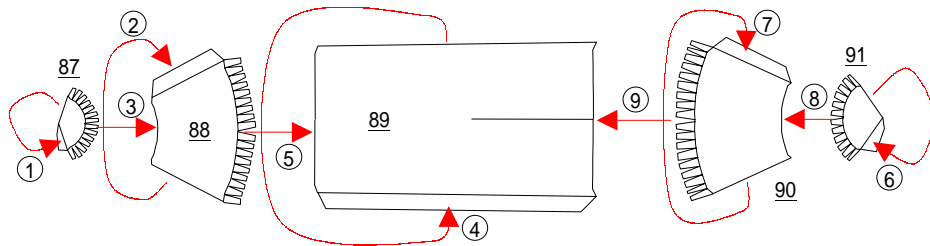

マトラ550マジック
シュペル530

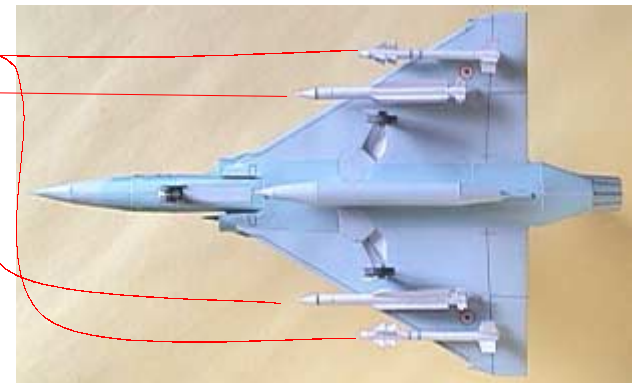

折り線図

