

2. 地上姿勢で作る時は23・25・26の部品は
右図のように赤線を切り取っておきます。

赤線で切り取ります

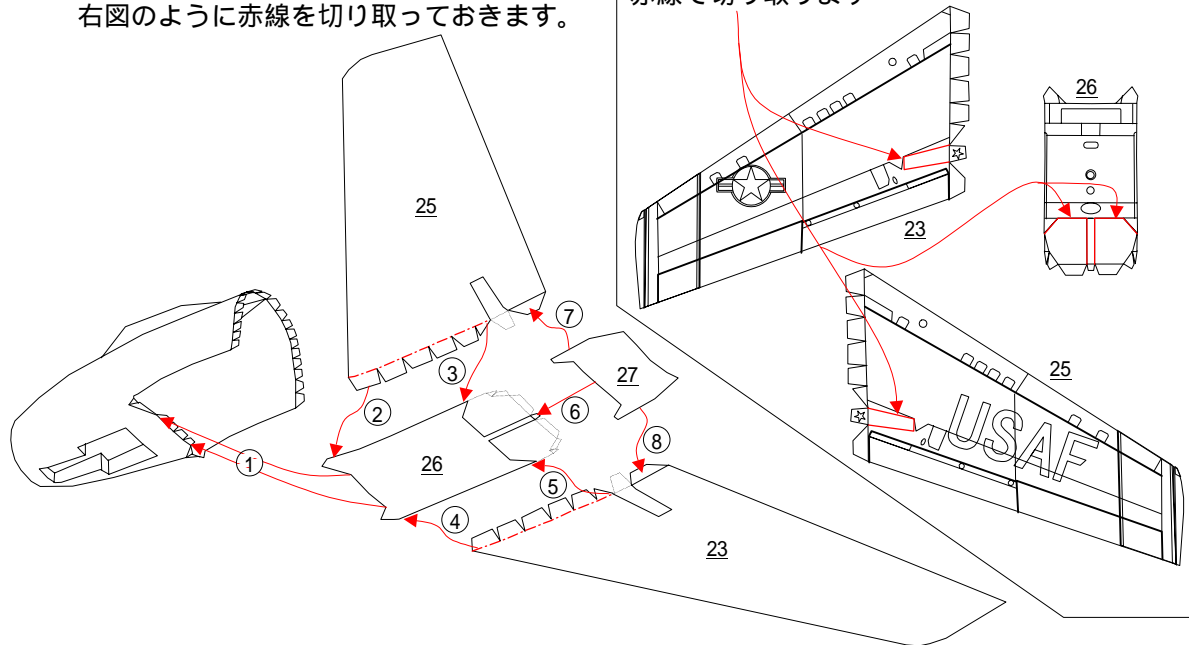

3. 地上姿勢で作る時に作成します。飛行姿勢で作る時は不要です

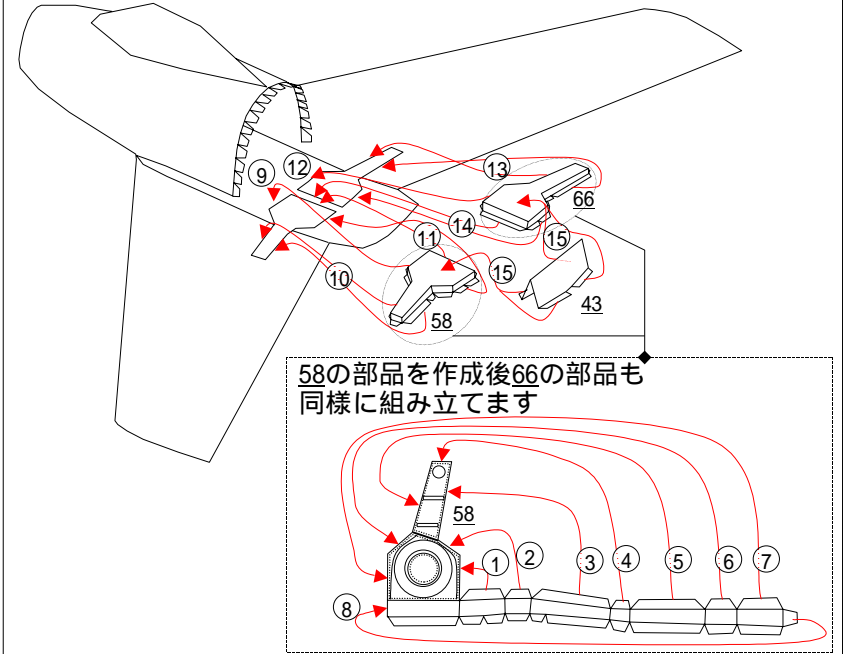

58の部品を作成後66の部品も
同様に組み立てます

4.

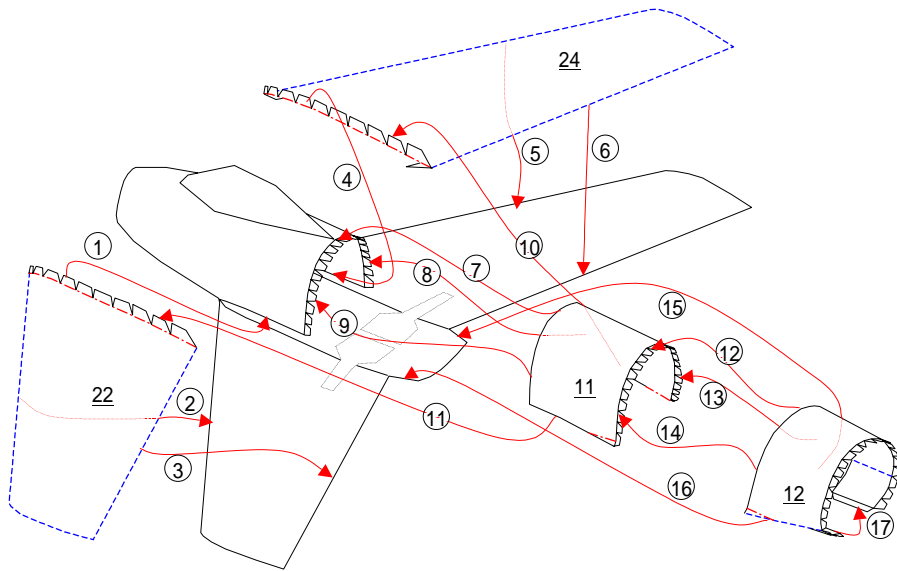

5.

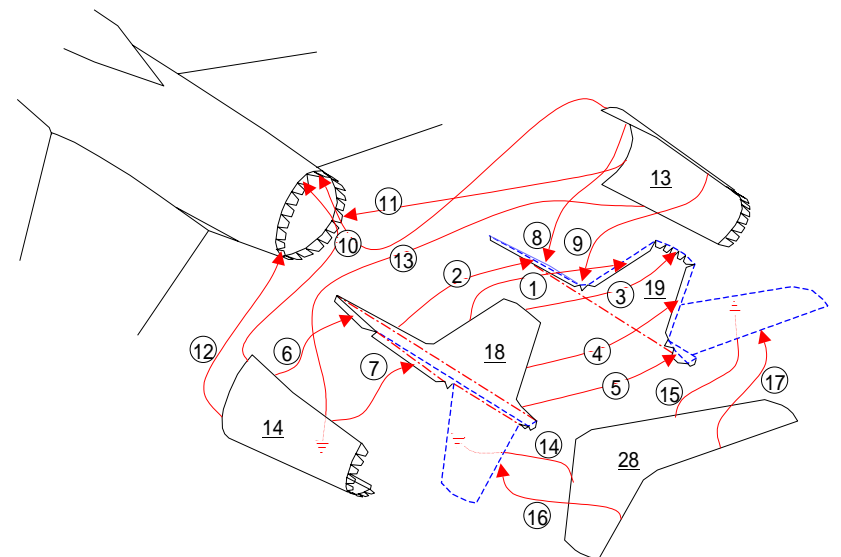

6 .

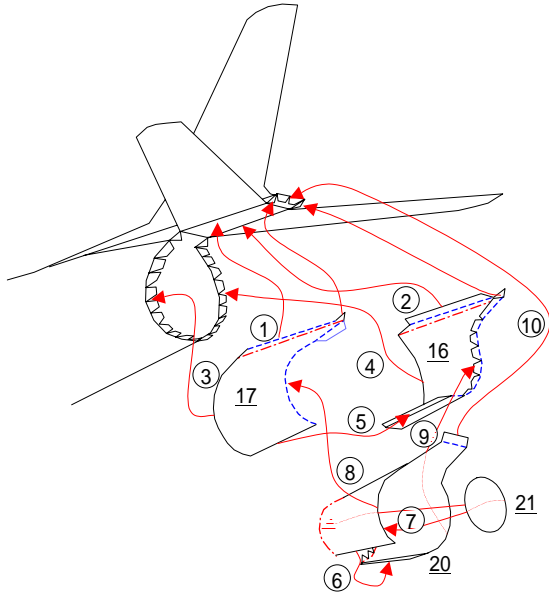

7 . 地上姿勢で作る時に作成します。
飛行姿勢で作る時は不要です

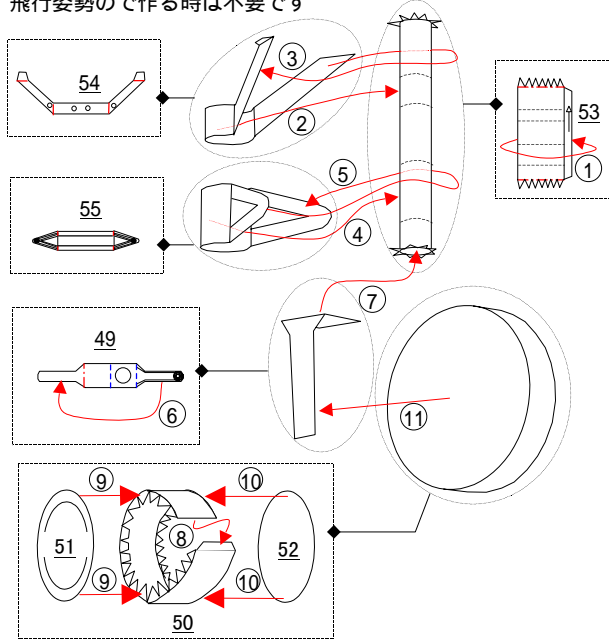

8 . 地上姿勢で作る時に作成します。
飛行姿勢で作る時は不要です
61 ~ 65の部品を作成後、69 ~ 73の
部品も同様に作成します。

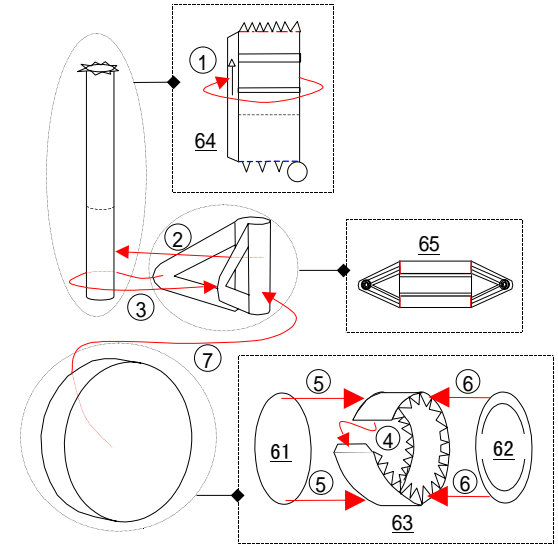

9 . 29 ~ 34の部品を作成後、36 ~ 42の部品も同様に作成します。

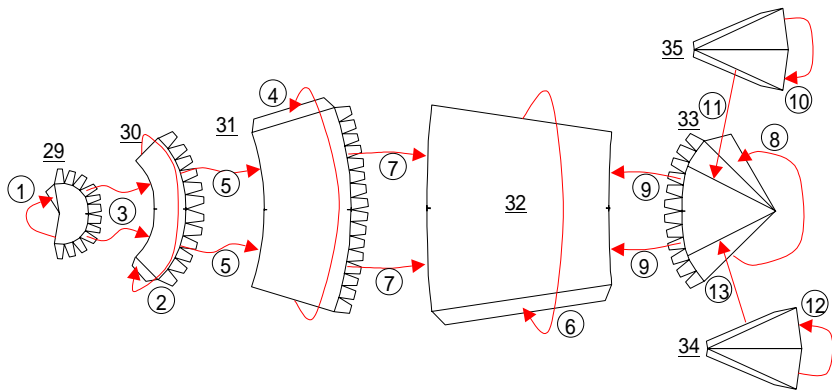

10 .

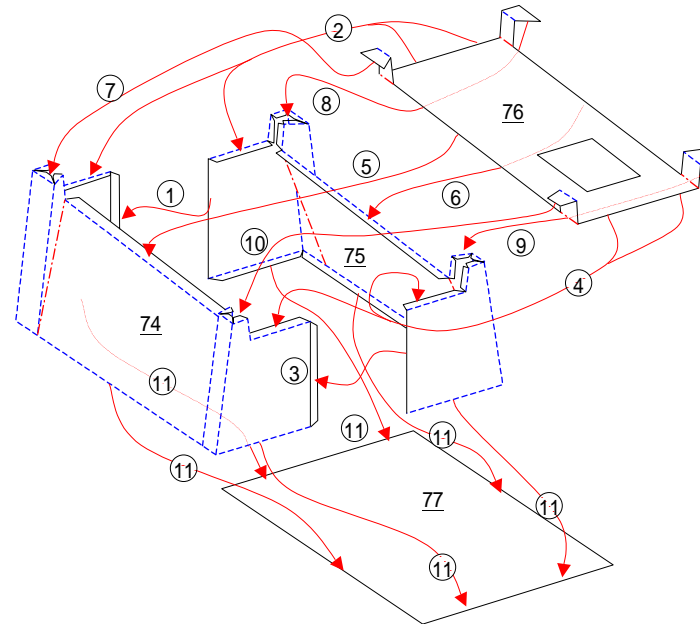

11. 飛行姿勢で作る時は ~ まで作って完成です。
 地上姿勢で作る時は ~ 最後まで作って完成です。

