

3. 兵器倉開で作成するときは作成します、
兵器倉閉の時は作成は不要です。

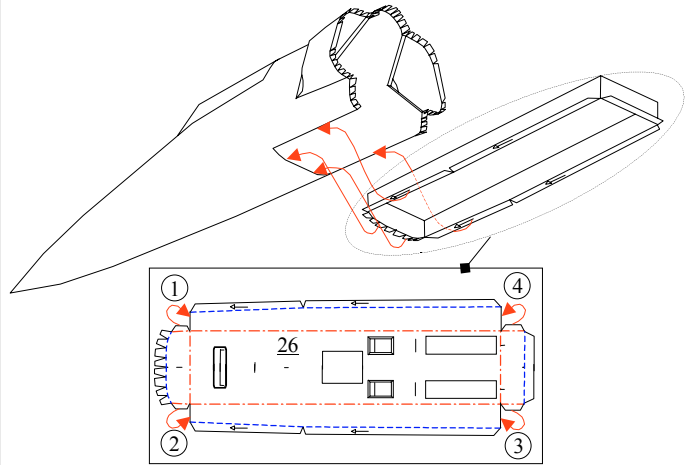

4. 兵器倉開、又は兵器倉閉のどちらかを選択して作成します。

兵器倉開で作る時
部品104・105の赤線部分を切取ってから組立て
ます。

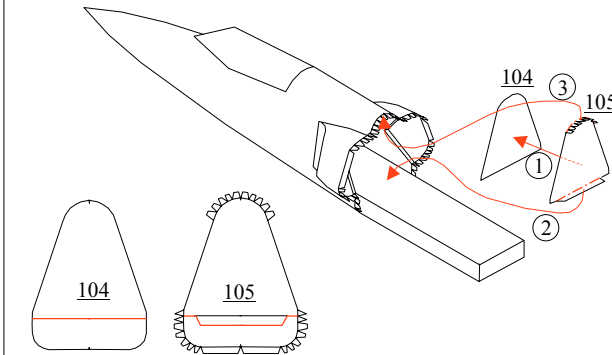

兵器倉閉で作る時

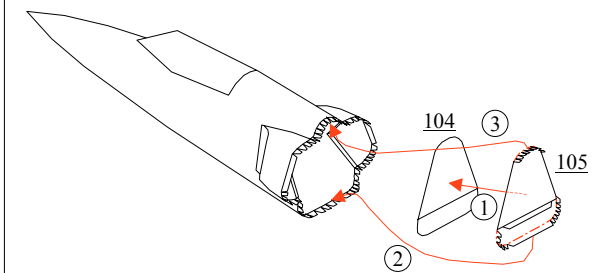

5. 主翼は前側だけ接着します(後側は後で接着します)

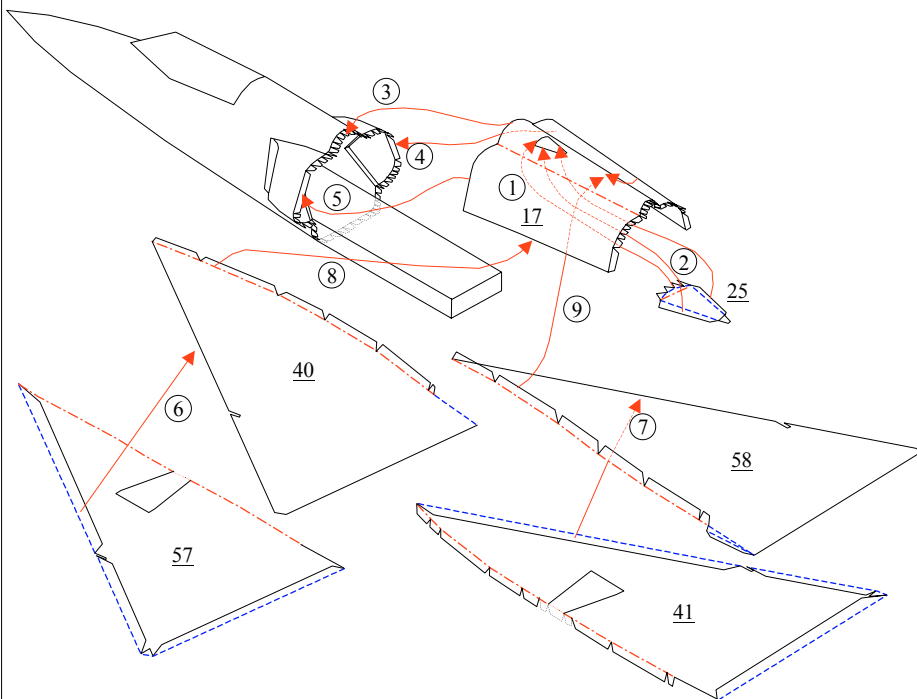

6. 兵器倉開、又は兵器倉閉のどちらかを選択して作成します。

兵器倉開で作る時
部品19・20の赤線部分を切取ってから組立て
ます。

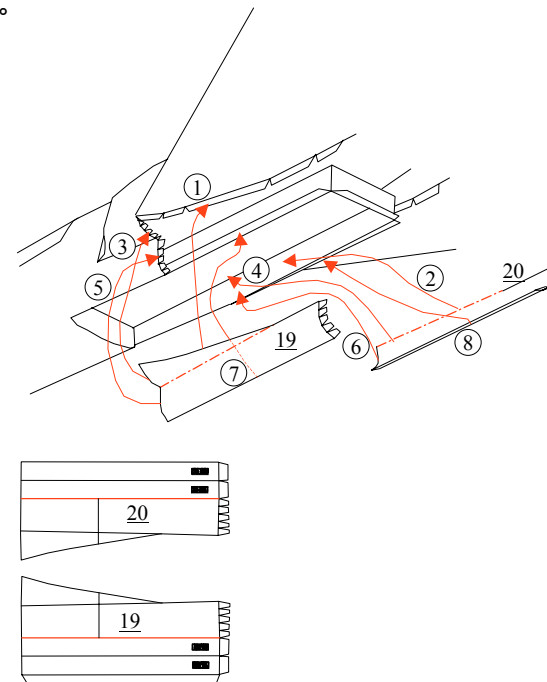

兵器倉閉で作る時

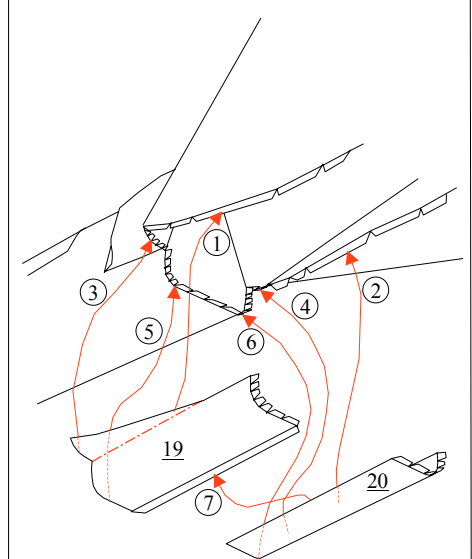

7. 地上姿勢、又は飛行姿勢のどちらかを選択して作成します。

地上姿勢で作成用

部品21・22は赤線で切り離して両端を使用します

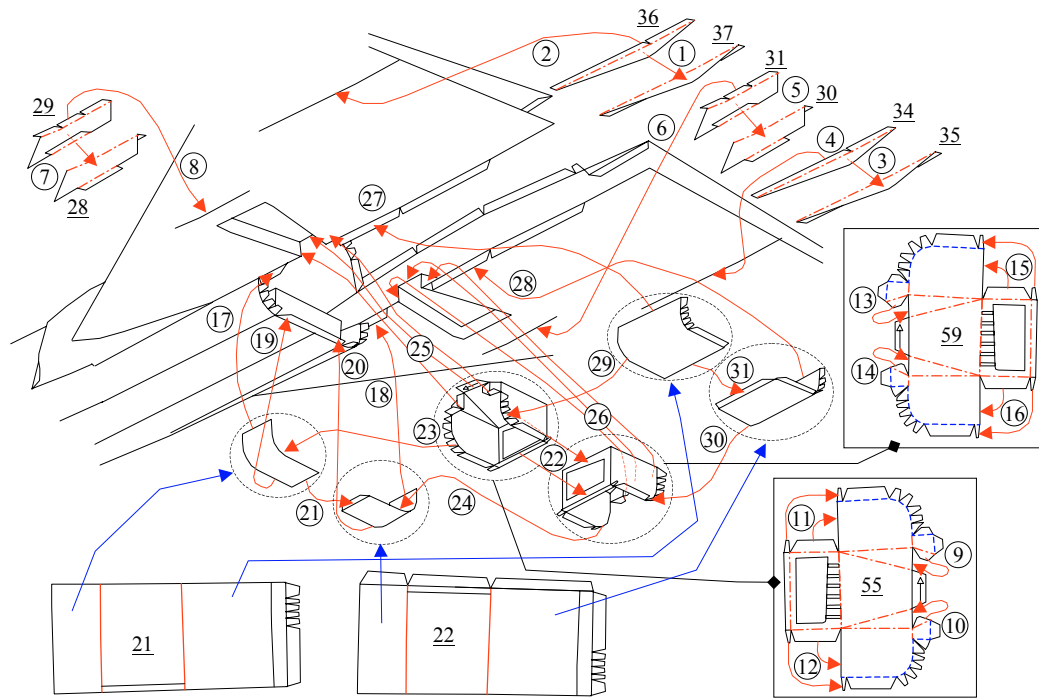

飛行姿勢で作成用

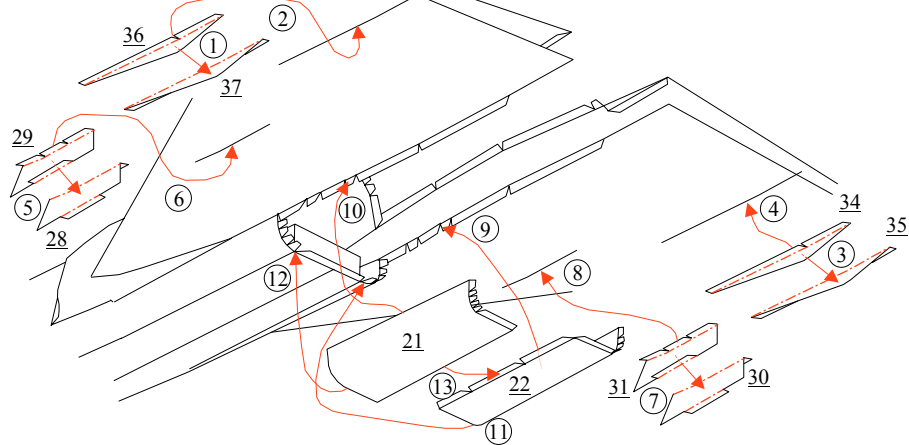

8.

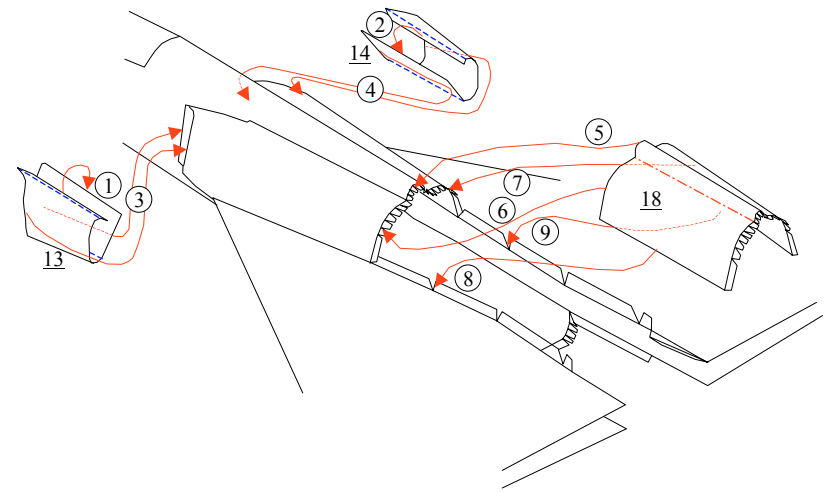

9.

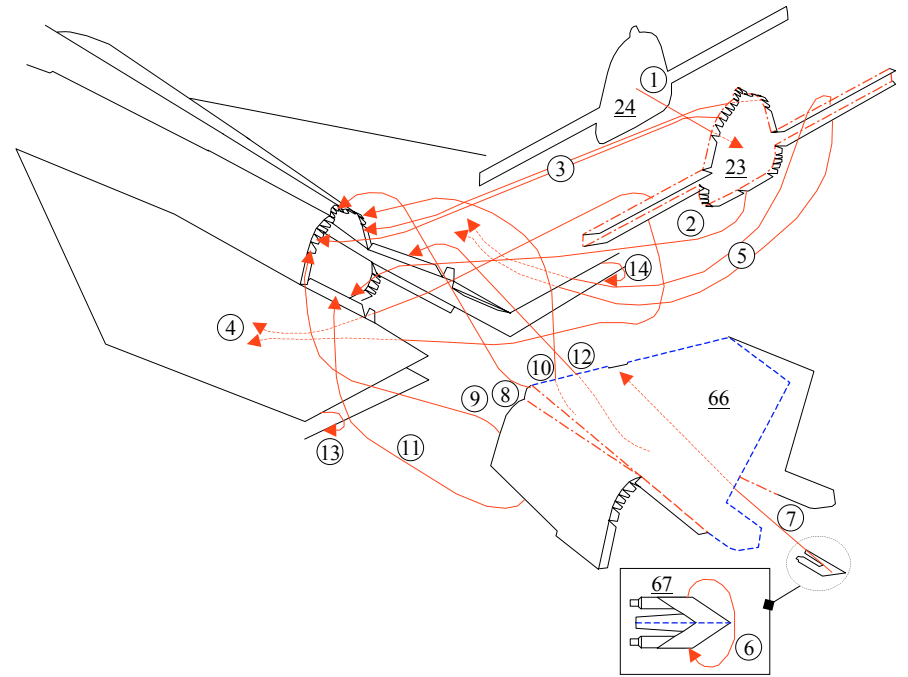

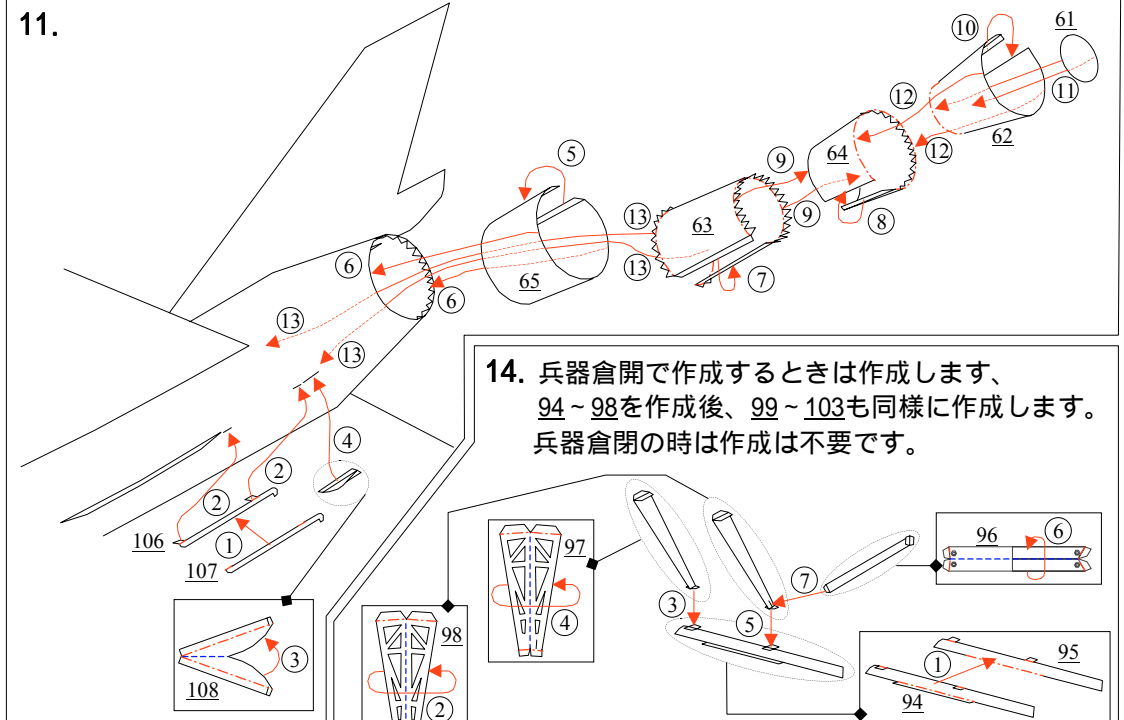
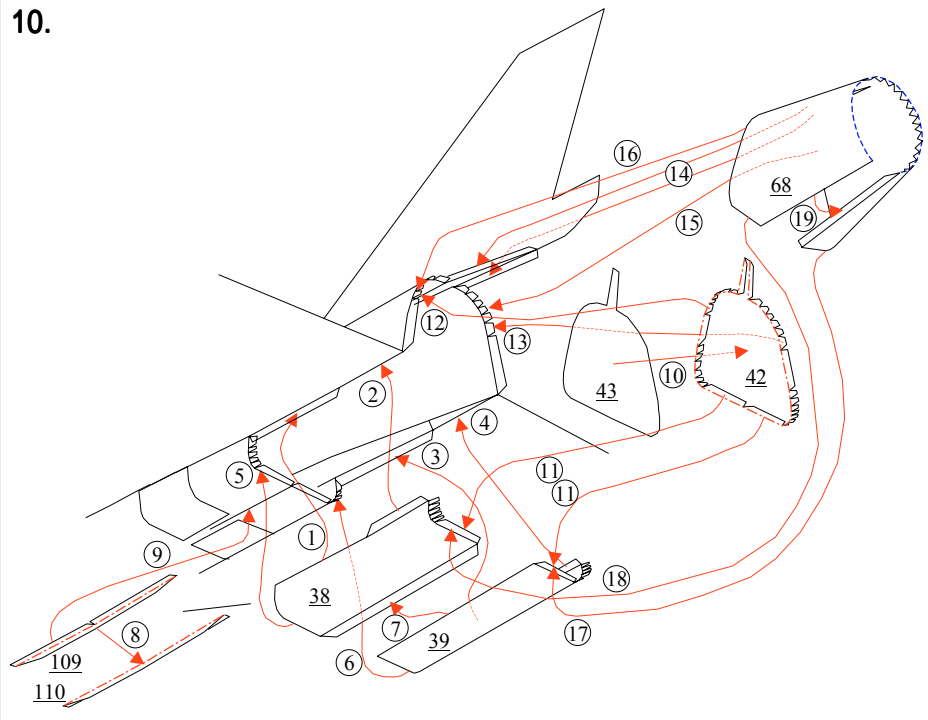

14. 兵器倉開で作成するときは作成します、
94～98を作成後、99～103も同様に作成します。
兵器倉閉の時は作成は不要です。

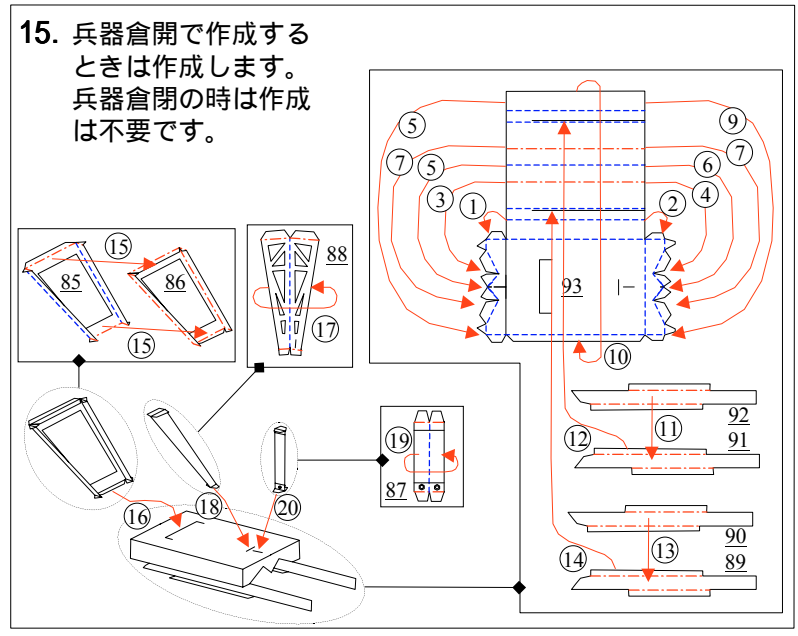
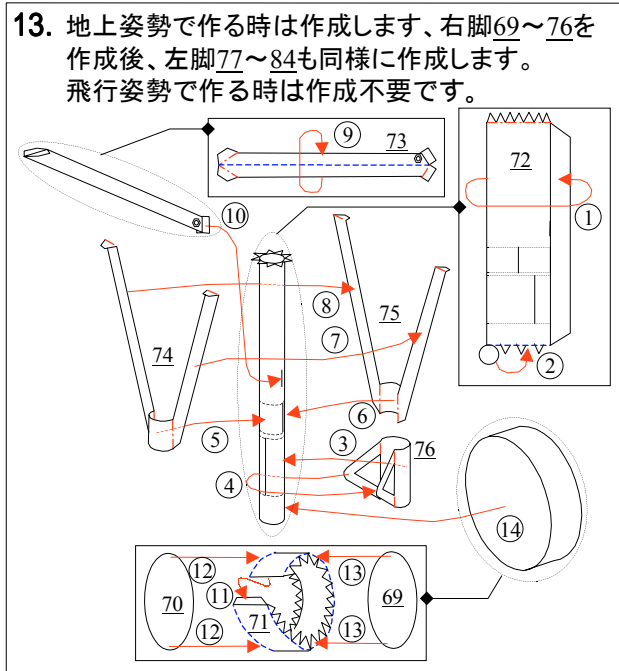
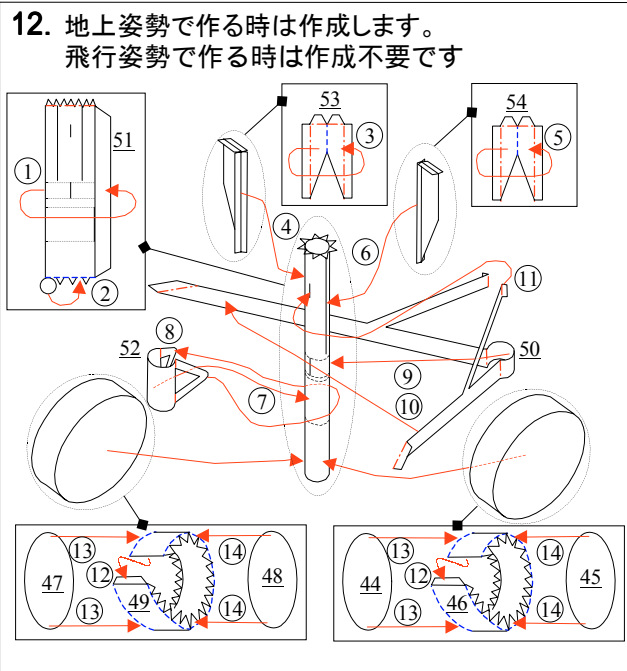

16. 111 ~ 115を作成後、116 ~ 120も同様に作成します。

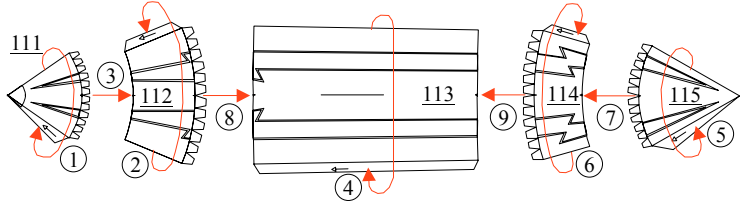

17. 兵器倉開で作成するときは作成します。

121 ~ 127を作成後、128 ~ 148も同様に作成します
兵器倉閉の時は作成は不要です。

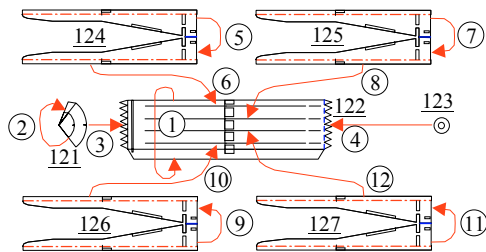

18.

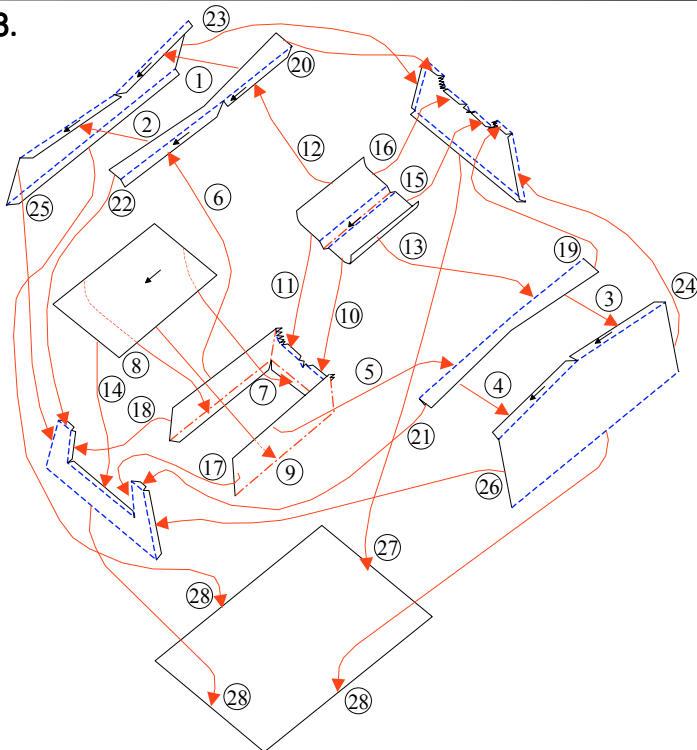

19. タ飛行姿勢で作るときは16.で作った部品を接着して作成終了です。

